

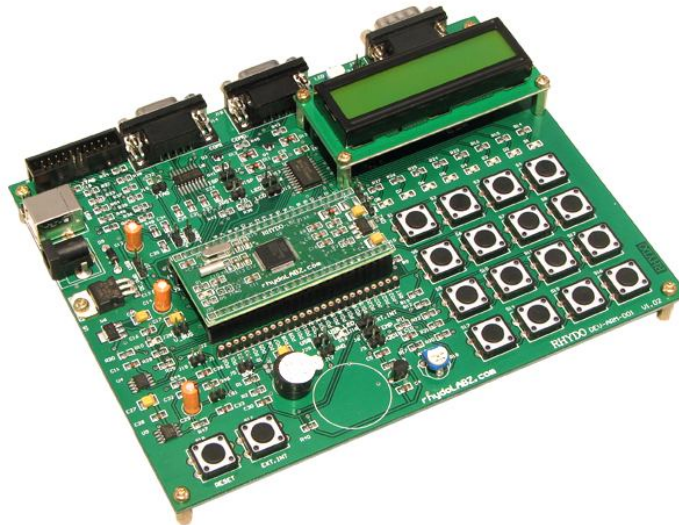

eCee NXP LPC 2138 ARM Development Board Quick Start Guide



Rhydo Technologies (P) Ltd.

(An ISO 9001:2008 Certified R&D Company)

Golden Plaza, Chitoor Road,

Cochin – 682018, Kerala State, India

Phone : 0091- 484-2370444, 2371666

Cell : 0091- 99466 70444

Fax : 0091 - 484-2370579

E-mail : info@rhydolabz.com, sales@rhydolabz.com

WebSite : <http://www.rhydolabz.com>



rhydolabz.com

CONTENTS

CHAPTER-1: OVERVIEW

- ❖ Features
 1. Base Board Features
 2. Header Board Features
- ❖ eCee NXP LPC 2138 Package Contents
- ❖ NXP LPC 2138 Specification

CHAPTER-2: HARDWARE INTRODUCTION

- ❖ eCee NXP LPC 2138 Function Module
- ❖ Interface Overview
- ❖ Power
- ❖ Clock source

CHAPTER-3: INTERFACING eCee LPC 2138

- ❖ Connecting the eCee NXP LPC 2138 Development Board
- ❖ Programming Steps
 - Automatic mode
 - Manual mode



CHAPTER-1: OVERVIEW



The eCee LPC 2138 Development and Evaluation Board from RhydoLabz can be used to evaluate and demonstrate the capabilities of NXP LPC 2138 microcontrollers. The board (with a base board and header board) is designed for general purpose applications and includes a variety of hardware to exercise microcontroller peripherals. The LPC 2138 Board contains all hardware components that are required in a single-chip LPC 2138 system plus 2 COM ports for serial RS232 output and interfaces like Lcd, Buzzer, Keyboard, Temperature Sensor, Potentiometer, Led's, EEPROM etc .

FEATURES

- Compact and Ready to use design
- Professional EMI/RFI Complaint PCB Layout Design for Noise Reduction

BASE BOARD FEATURES

- Supports LPC2129/32/48 Header Boards
- Includes LPC2138 Header Board
- No separate programmer required (On-Chip Boot loader)
- No Separate power adapter required (USB power source)
- Two RS-232 Interfaces (For direct connection to PC's Serial port)
- On Board Two Line LCD Display (2x16) (with jumper select option)
- On Board 8 LED Interface to test Port pin (with jumper select option)
- On Board Pot interface to ADC
- On Board Temperature Sensor Interface
- On Board Buzzer Interface
- On Board 4x4 (16 Keys) Matrix Keyboard
- On Board I²C EEPROM
- On Board External Interrupt Button
- On Board Connector for PWM Output
- PWM controlled LCD backlight
- On Board Connector for Analog Output



- On Board Speaker Output
- LF Amplifier LM 386
- Adaptor (any standard 9-12V power supply) option
- On Board Power LED Indicator
- On Board Reset button
- All Port Pins available at Berge Strip
- On Board JTAG Connector for Debugging/Programming
- Power Supply Reverse Polarity Protection
- Three On Board DB9 Connectors (Two for UART and One for CAN)
- On Board USB Connector
- On Board 1 Amp Voltage Regulator
- On Board Connector for regulated 3V3 output
- On Board Connector for regulated 5V output
- Controller Area Network (CAN) transceiver (optional)
- Can be used as main board for developing applications

HEADER BOARD FEATURES

- Easy to use DIP Package
- Includes NXP LPC 2138 Microcontroller
- On Board Power LED Indicator
- On Board JTAG Jumper
- On Board 10 MHz Crystal Oscillator
- On Board 32.768 KHz Crystal for RTC
- On Board 3.3V Regulator
- On Board Power Supply de-Coupling Capacitors
- All Port Pins available at Berge Strip
- Header Module can be removed for developing your circuit



eCee LPC 2138 PACKAGE INCLUDES

- Fully Assembled and Tested eCee LPC2138 Development board
- Software CDROM with
 - Schematic
 - Programming Software
 - Sample Hex Code
 - Example Codes for
 - Led Blinking LCD Display
 - Matrix Keyboard DAC Interfacing
 - I²C Protocol RTC Interfacing
 - Led Control with Timer UART Communication
 - PWM Generation Buzzer Interfacing
 - ADC Interfacing



LPC 2138 SPECIFICATION

- High Performance 32-bit ARM7TDMI-S™ CPU
- 512 KB Programmable Flash Memory provides minimum of 10,000 erase/write cycles and 10 years of data-retention.
- 32 KB Data Memory (SRAM)
- In-System/In-Application Programming (ISP/IAP) via on-chip boot-loader software.
- Single Flash sector or full chip erase in 400 ms and 256 bytes programming in 1 ms.
- EmbeddedICE and Embedded Trace interfaces offer real-time debugging with the on-chip RealMonitor™ software and high speed tracing of instruction execution.
- Two 8-channel 10-bit A/D with conversion times as low as 2.44 us per channel.
- Single 10-bit D/A converter provide variable analog output.
- Two 32-bit Timers/External event counters.
- Four Capture and four Compare channels.
- PWM unit with six output pins.
- Low power Real-time clock with independent power and dedicated 32 kHz clock input.
- Multiple serial interfaces including two UARTs, two Fast I²C (400 kbit/s), SPI™ and SSP with buffering and variable data length capabilities.
- Vectored interrupt controller with configurable priorities and vector addresses.
- Up to 47 of 5 V tolerant general purpose I/O pins.
- Up to nine edge or level sensitive external interrupt pins.
- 60 MHz maximum CPU clock available from programmable on-chip Phase-Locked Loop (PLL) with settling time of 100us.
- On-chip integrated oscillator operates with external crystal in range of 1 MHz to 30 MHz or with external oscillator from 1 MHz to 50 MHz.
- Power saving modes include Idle and Power-down.
- Individual enable/disable of peripheral functions.
- Processor wake-up from Power-down mode via external interrupt or Real-time Clock.
- Single power supply chip with Power-On Reset (POR) and Brown-Out Detection (BOD):
- CPU Operating Voltage range of 3.0 V to 3.6 V



CHAPTER-2: HARDWARE INTRODUCTION

FUNCTION MODULE

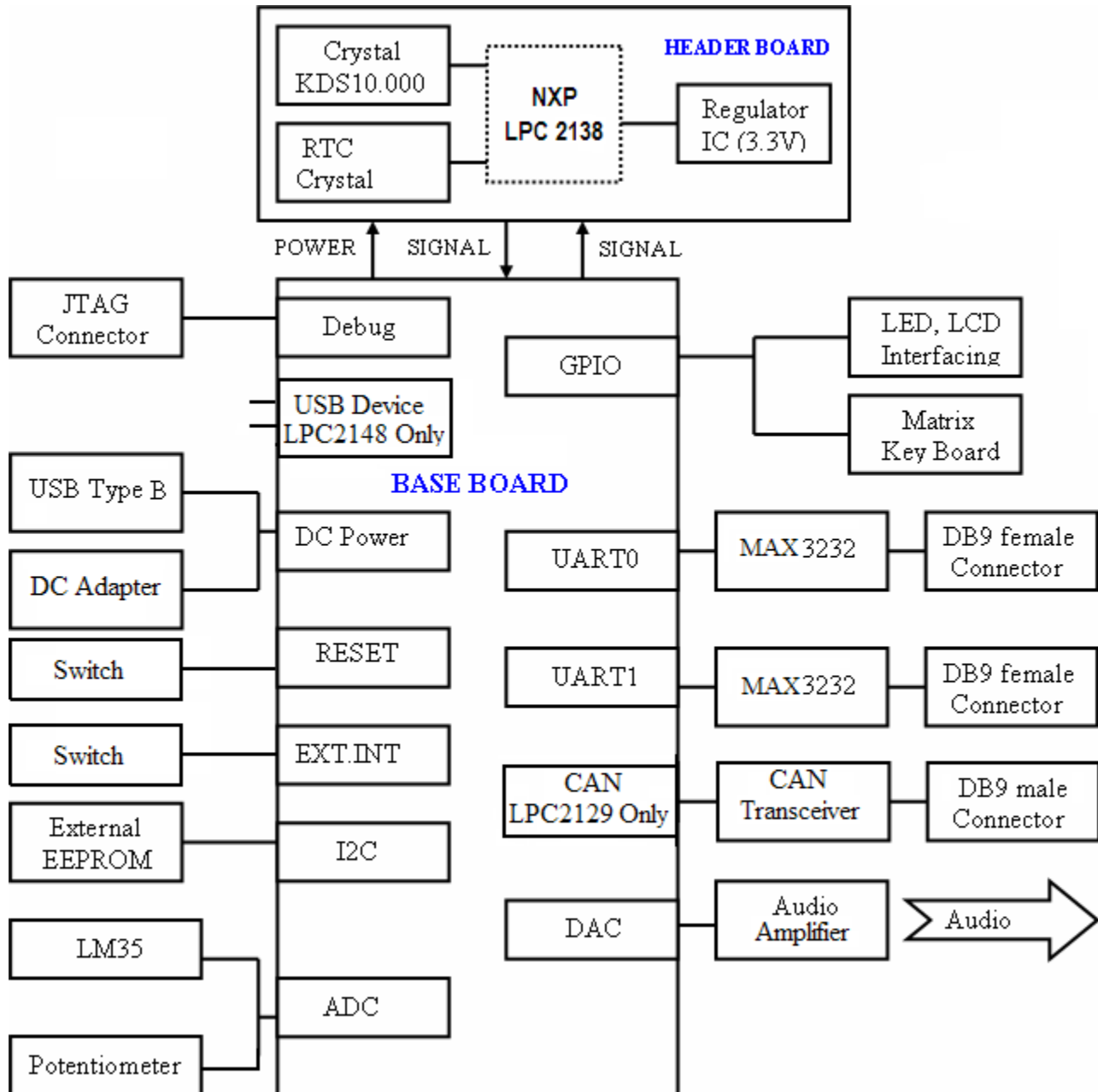

INTERFACE OVERVIEW

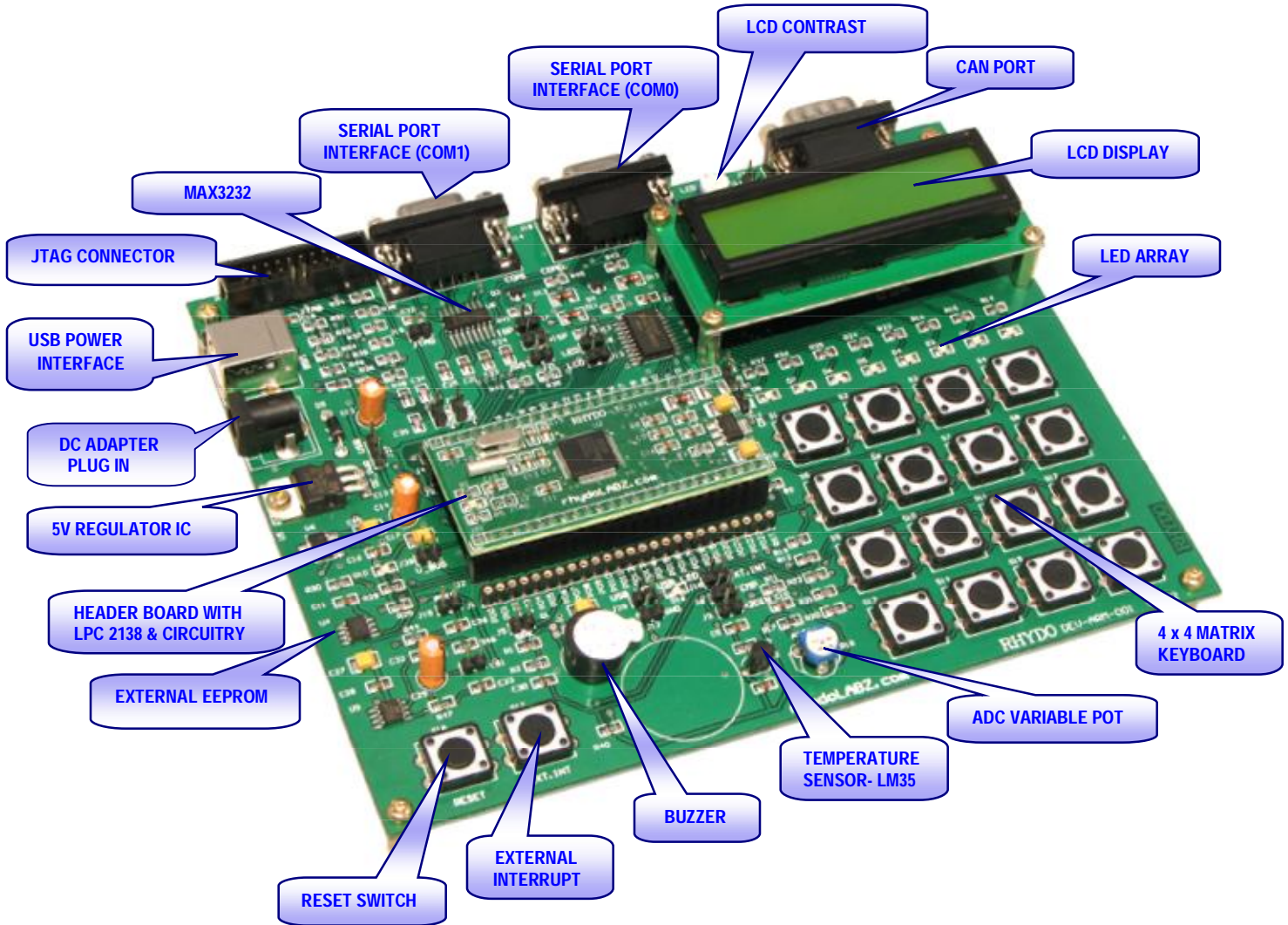

POWER SUPPLY

eCee NXP LPC 2138 Board has two power supplies; you can choose one of the following ways to supply power

- (1) Through an Adaptor (any standard 9-12V power supply)
- (2) Through the motherboard USB port

The external Power Supply circuit is given below:

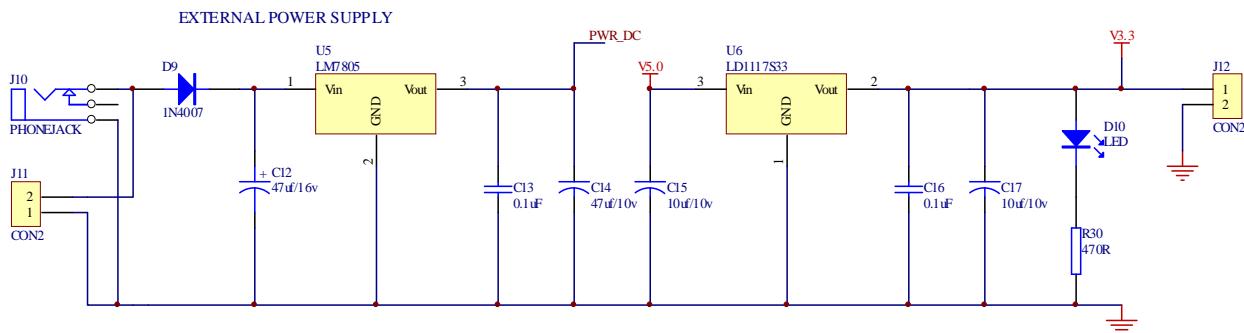

CLOCK SOURCE

eCee NXP LPC 2138 evaluation board has two clock sources:

- 32.768 KHz as the RTC clock source
- 10 MHz as the MCU clock source



CHAPTER-3 : INTERFACING eCee LPC 2138

CONNECTING THE DEVELOPMENT BOARD

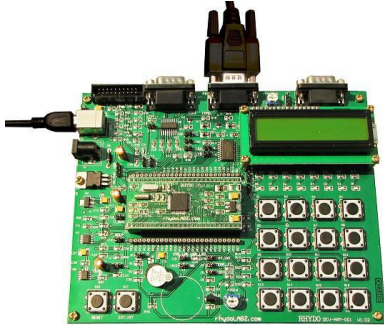

The eCee LPC 2138 requires a 9-12V adapter or USB connection for power and either a serial connection for In-system programming, or the JTAG connector.

Use LPC2000 Flash Utility Software at the PC side for programming through Serial port. Connect eCee LPC 2138 Development board to your PC using USB cable (for powering it) and serial cable (for In-serial programming) as shown in the figure.

***Note:** Serial cable should be **connected to COM0** Port of the development board for downloading. **Corresponding jumpers** has to be inserted (see circuit diagram) for the functioning of each peripheral.*

CONNECTIONS

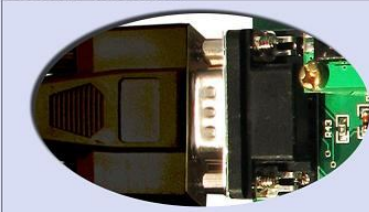
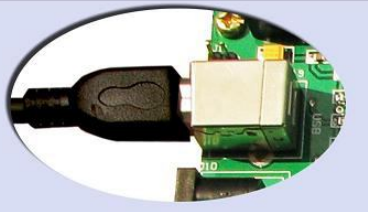
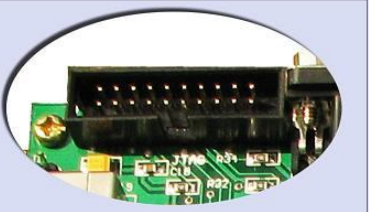
| | | |
|---|---|---|
|  |  |  |
| RS232 | USB POWER | JTAG |

PROGRAMMING STEPS

eCee NXP LPC 2138 development board supports **two modes** of programming

I. AUTOMATIC MODE

1. Configure LPC Flash Utility software at the PC side
 - a. Browse your hex file here.
 - b. Select Crystal frequency here.
 - c. Enable DTR/RTS for Reset and boot loader selection.
 - d. Select your COM port and Set baud rate (9600) here.
2. Connect system serial port to COM port of eCee LPC 2138 .
3. **Put jumper on RST(J21) , ISP(J17) and Reset the board**
4. Click “Read Device ID” and wait till Device Id is shown
5. Click “Upload to Flash” button in the flash utility software and wait till the programming is over.
6. Remove jumper on ISP and RST
7. Now Reset the development board

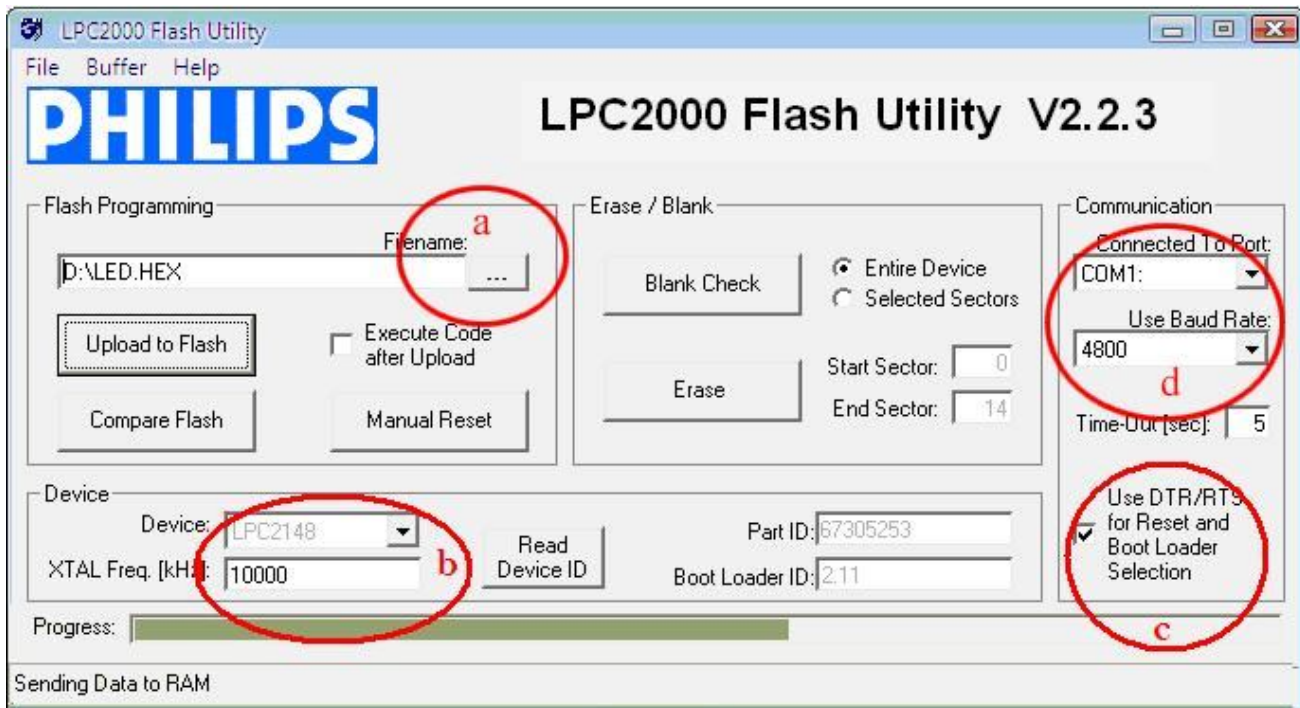

II. MANUAL MODE

1. Configure LPC Flash Utility software at the PC side
 - a. Browse your hex file here.
 - b. Select your COM port and Set baud rate (9600) here.
 - c. Disable DTR/RTS for Reset and boot loader selection.
2. Connect system serial port to COM port of eCee LPC 2138 .
3. Put jumper on ISP(J17),*ISP(J20)
4. Click "Read Device ID"
5. The software prompts you to reset the development board.
6. Press Reset button (S18) and press OK
7. Wait till Device Id is shown
5. Click "Upload to Flash" button in the flash utility software and wait till the programming is over.
6. Remove jumper on ISP (J17),*ISP (J20)
7. Now Reset the development board

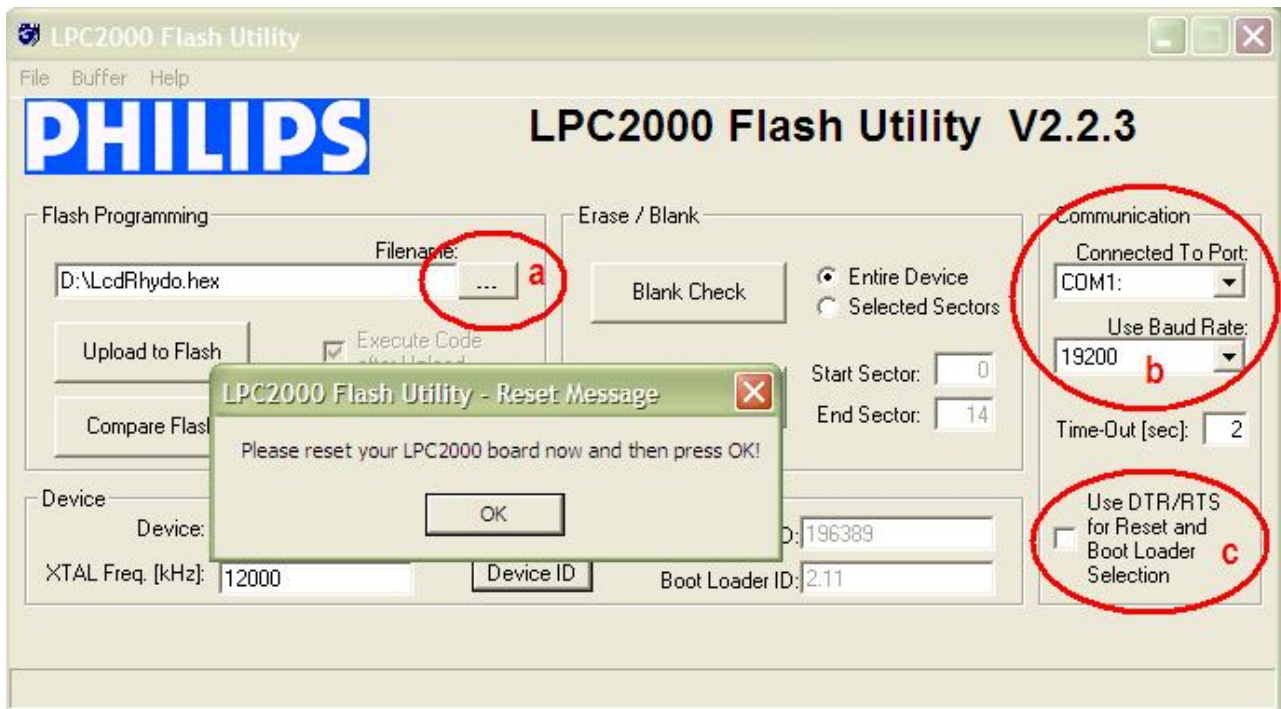



TECHNICAL SUPPORT

If you are experiencing a problem that is not described in this manual, please contact us. Our phone lines are open from 9:00 AM – 5.00 PM (*Indian Standard Time*) Monday through Saturday excluding holidays. Email can be sent to support@rhydolabz.com

LIMITATIONS AND WARRANTIES

This product is intended for personal or lab experimental purpose and in no case should be used where it harmfully effect human and nature. No liability will be accepted by the publisher for any consequence of its use. Use of the product software and or hardware is with the understanding that any outcome whatsoever is at the users own risk. All products are tested for their best performance before shipping, still rhydoLABZ is offering One year Free service warranty (Components cost + Shipping cost will be charged from Customer).

DISCLAIMER

Copyright © Rhydo Technologies (P) Ltd

All rights are reserved. Reproduction in whole or in part is prohibited without the prior written consent of the copyright owner. The information presented in this document does not form part of any quotation or contract, is believed to be accurate and reliable and may be changed without notice.

Rhydo Technologies (P) Ltd.

(An ISO 9001:2008 Certified R&D Company)

Golden Plaza, Chittoor Road,

Cochin – 682018, Kerala State, India

Phone : 0091- 484-2370444, 2371666

Cell : 0091- 99466 70444

Fax : 0091 - 484-2370579

E-mail : info@rhydolabz.com, sales@rhydolabz.com

WebSite : <http://www.rhydolabz.com>



rhydolabz.com